

Model G9-95 Rotary Gear Pump

Surex rotary gear pumps designed for foam extinguishing system. They are Self-Priming and can pump Multiple Viscosities of Foam or Water. This versatile design is suitable for Electric, PTO, Diesel/Gasoline Engine, Water Driven or Hydraulic drive motors.

Design Features:

- Timing Gears Synchronize the Two Pumping Rotors.
- Timing Gears Allow for DRY Running Without Damage.
- No Rotor Contact Allows for Pumping Foam or Water.
- Water Can Be Used for: Calibration, Testing and Training.

Technical Data:

Max Pressure: 2.0MPa | 20bar
Max Speed: 1800RPM
Viscosity : 9500cp max.[1]
Connection Diameter: DN80(88.9 O.D.)、3"
Connection Type: Groove、Thread、Flange
Approvals: FM

[1]Brookfield viscometer, spindle #4, speed 30rpm.



Materials :

Pump body: Red Brass, ASTM B584 C83600
Rotor: Stainless Steel 17-4PH
Red Brass, ASTM B584 C83600
Liners: Red Brass, ASTM B584 C83600
Front Cover: Red Brass, ASTM B584 C83600
Back Cover: Red Brass ASTM B584 C83600
Timing Gear: Alloy Steel 20CrMnTi (ASTM A29M)
Lip Seal : FPM

Performance -Water

Foam Pump	1000rpm			1200rpm			1500rpm			1800rpm			
	Pressure	Flow	Power	Torque	Flow	Power	Torque	Flow	Power	Torque	Flow	Power	Torque
	PSI	GPM	HP	LB-FT	GPM	HP	LB-FT	GPM	HP	LB-FT	GPM	HP	LB-FT
	72.5	91	8	43	119	10	45	160	14	49	202	18	52
	100	84	10	54	111	13	56	153	17	60	195	22	64
	150	73	14	74	100	17	76	142	23	81	184	29	86
	200	64	18	94	91	22	96	132	29	101	175	36	107
	250	57	22	114	84	27	117	125	34	119	168	43	126
	290	53	25	131	79	30	134	121	38	133	163	48	140

Dimensions

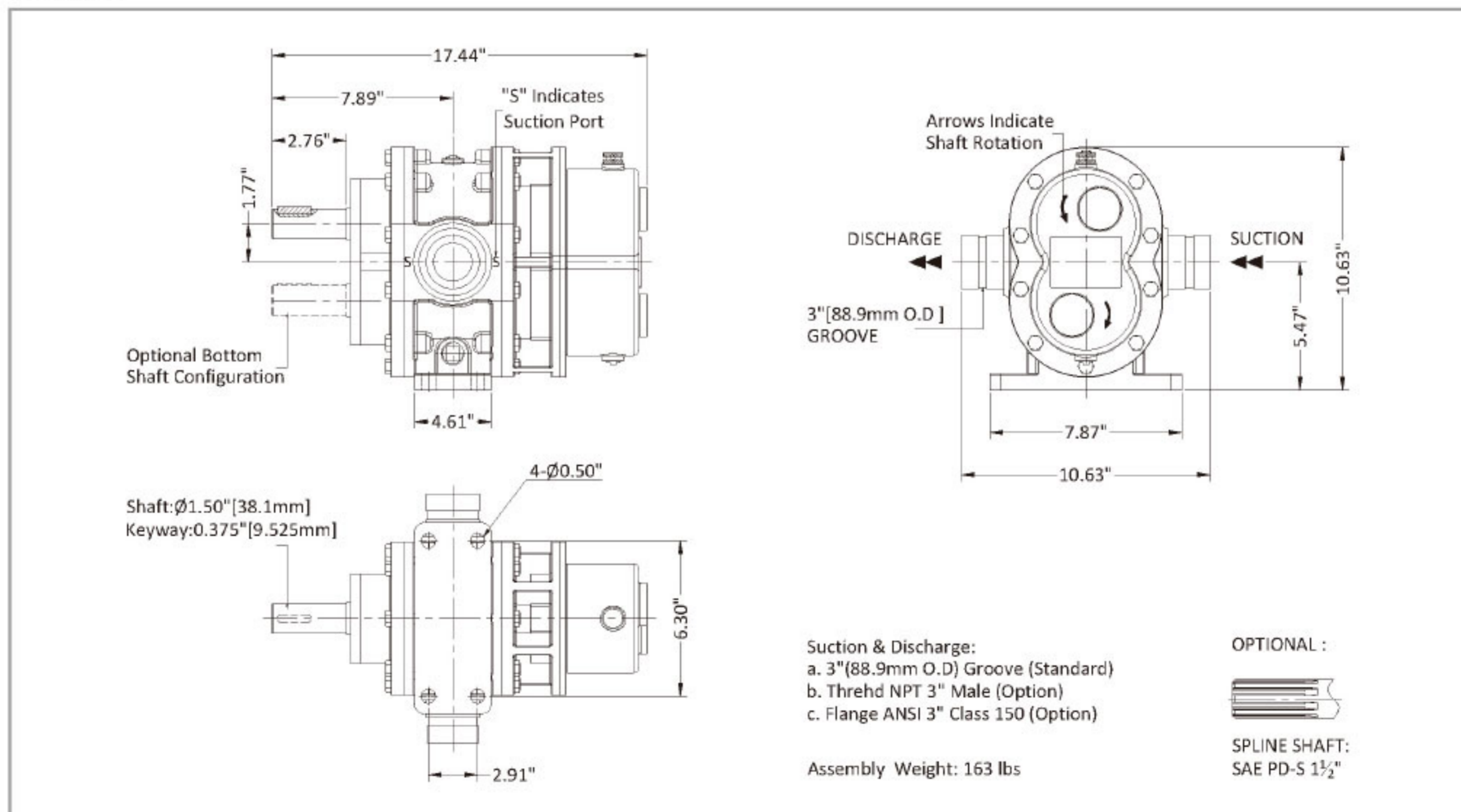

Model G9-95 Rotary Gear Pump

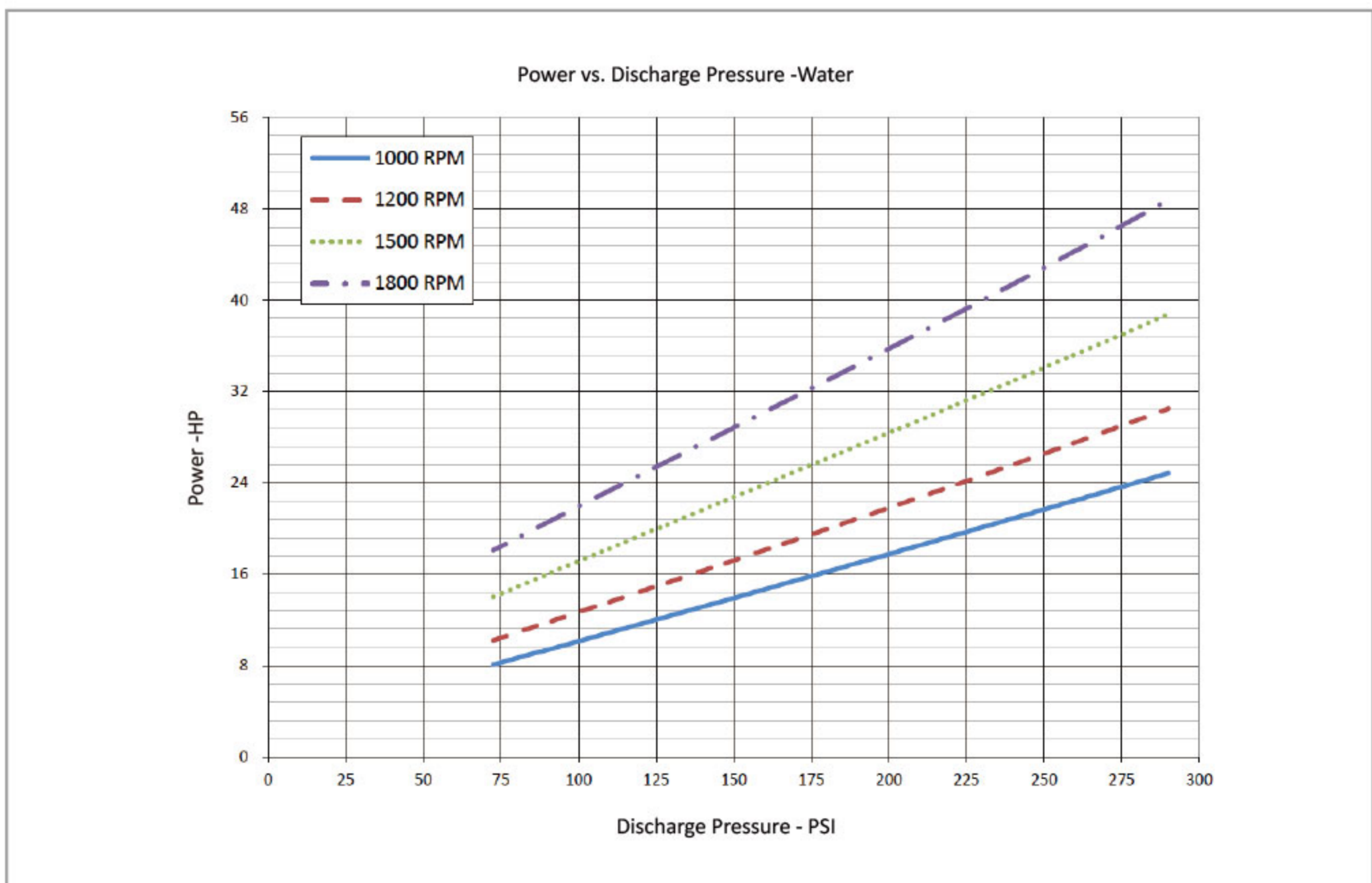
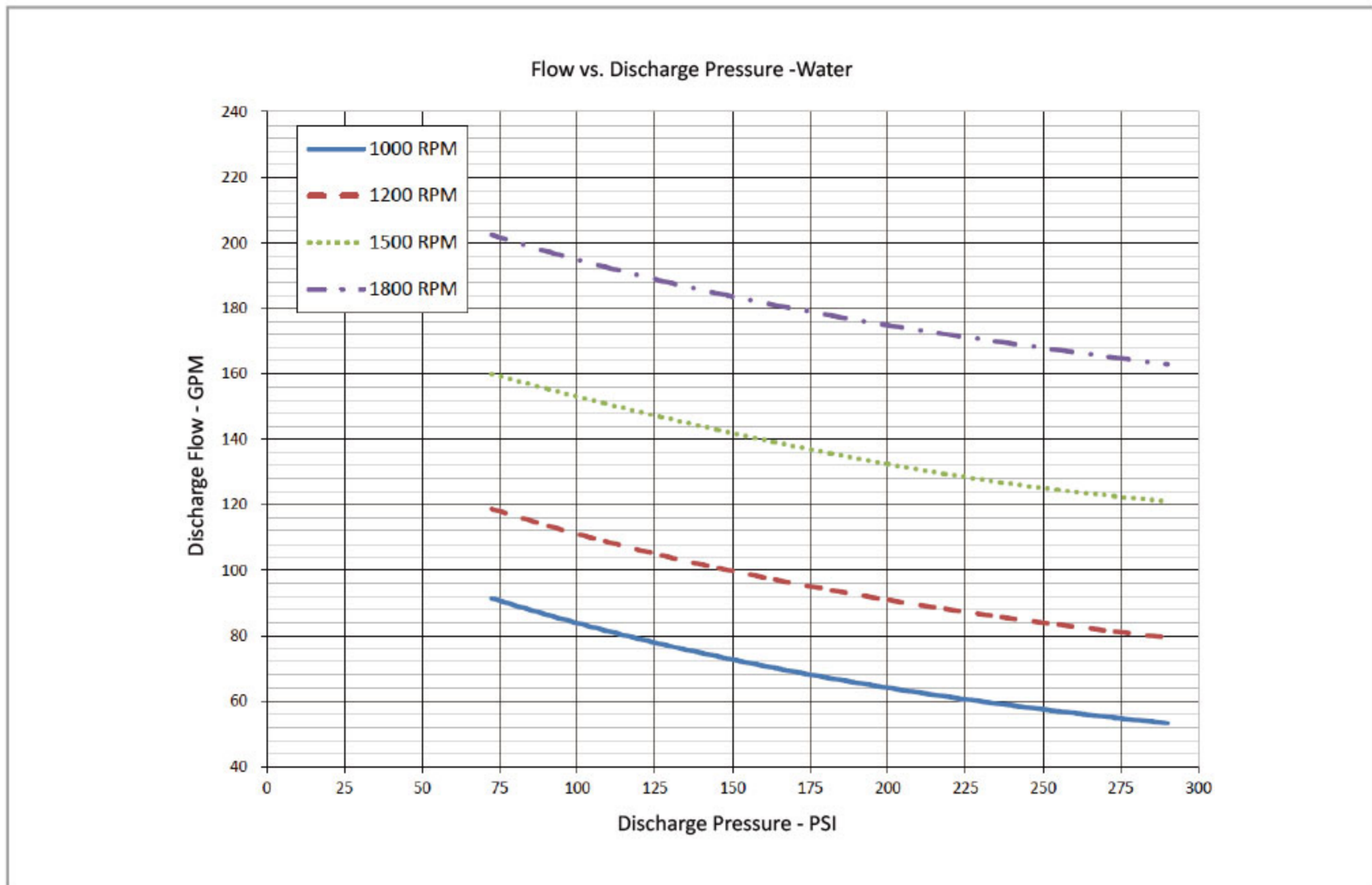

• The pump performance for foam concentrate, please contact Surex, or down load from www.surexfoam.com.