

Model G6-55 W/IEC Electric Motor Rotary Gear Pump Unit

Pump Unit Include:

- Model G6-55 Rotary gear pump FM Approved.
- UL listed or Non-listed TEFC Type Electric Motor*.
- Curved Jaw Elastomer Coupling.
- Carbon Steel Coupling Guard RAL3000(standard) or other color on request.
- Carbon Steel Base Plate, RAL3000(standard) or other color on request.

* Junction Box located on top or side of motor

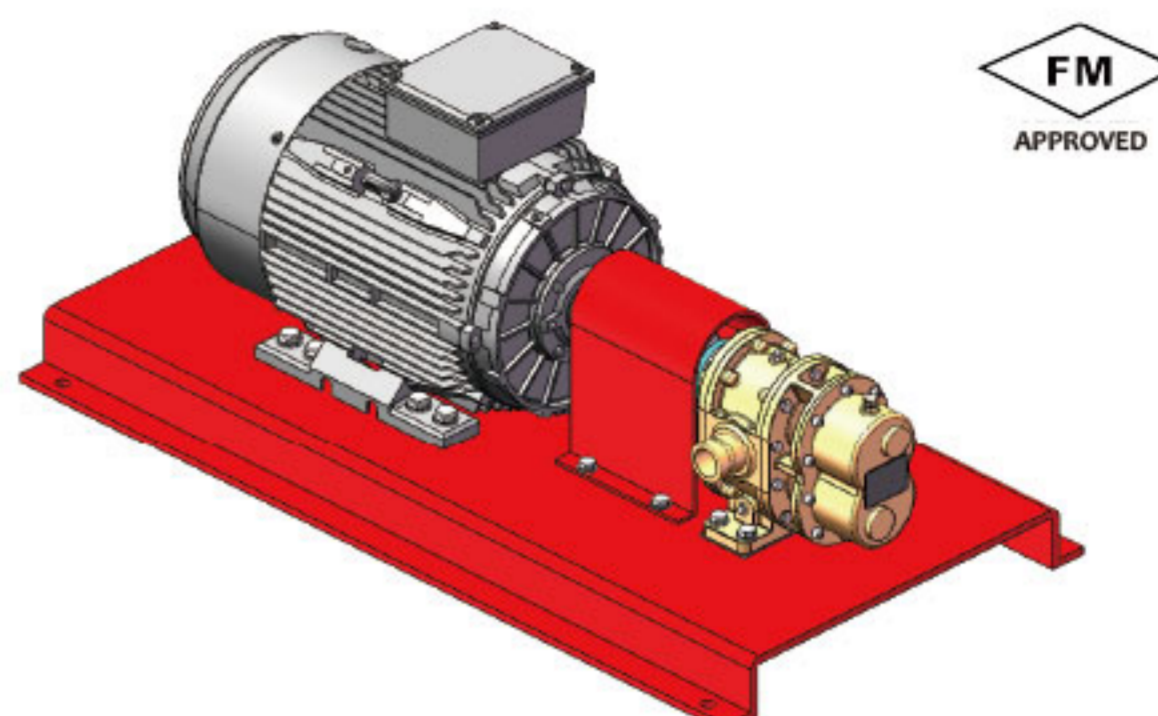

Technical Data:

Speed:	1450RPM
Connection Dia:	DN40(48.3mm O.D)
Connection Type:	Groove, Flange, Thread
Voltage:	380V/3P/50HZ
Enclosure:	IP 56

Performance

Speed	G6-55	
1500rpm	Flow Rate (Water)	Power
Pressure	L/min	Kw
5.0	176.2	4.00
5.5	174.1	4.21
6.0	172.2	4.42
6.5	170.2	4.62
7.0	168.3	4.82
7.5	166.4	5.02
8.0	164.6	5.22
8.5	162.8	5.41
9.0	161.1	5.61
9.5	159.4	5.80
10.0	157.8	6.00
10.5	156.2	6.20
11.0	154.6	6.40
11.5	153.1	6.59
12.0	151.6	6.79
12.5	150.2	6.99
13.0	148.8	7.19
13.5	147.5	7.40
14.0	146.2	7.60
14.5	144.9	7.80
15.0	143.7	8.00
15.5	142.5	8.20
16.0	141.3	8.40
16.5	140.2	8.60
17.0	139.0	8.81
17.5	137.9	9.01
18.0	136.9	9.21
18.5	135.8	9.41
19.0	134.8	9.60
19.5	133.8	9.80
20.0	132.8	10.00

Speed	G6-55	
1500rpm	Flow Rate (Foam)	Power
Pressure	L/min	Kw
5.0	197.8	4.00
5.5	196.8	4.19
6.0	195.9	4.39
6.5	195.0	4.59
7.0	194.1	4.79
7.5	193.2	4.99
8.0	192.3	5.19
8.5	191.5	5.39
9.0	190.7	5.59
9.5	189.9	5.80
10.0	189.1	6.00
10.5	188.4	6.20
11.0	187.7	6.40
11.5	187.0	6.60
12.0	186.4	6.80
12.5	185.8	7.00
13.0	185.2	7.20
13.5	184.6	7.40
14.0	184.0	7.60
14.5	183.4	7.80
15.0	182.9	8.00
15.5	182.3	8.20
16.0	181.7	8.40
16.5	181.2	8.60
17.0	180.6	8.80
17.5	180.0	9.00
18.0	179.4	9.20
18.5	178.7	9.40
19.0	178.1	9.60
19.5	177.4	9.80
20.0	176.6	10.00

Model G6-55 W/IEC Electric Motor Rotary Gear Pump Unit

Dimensions

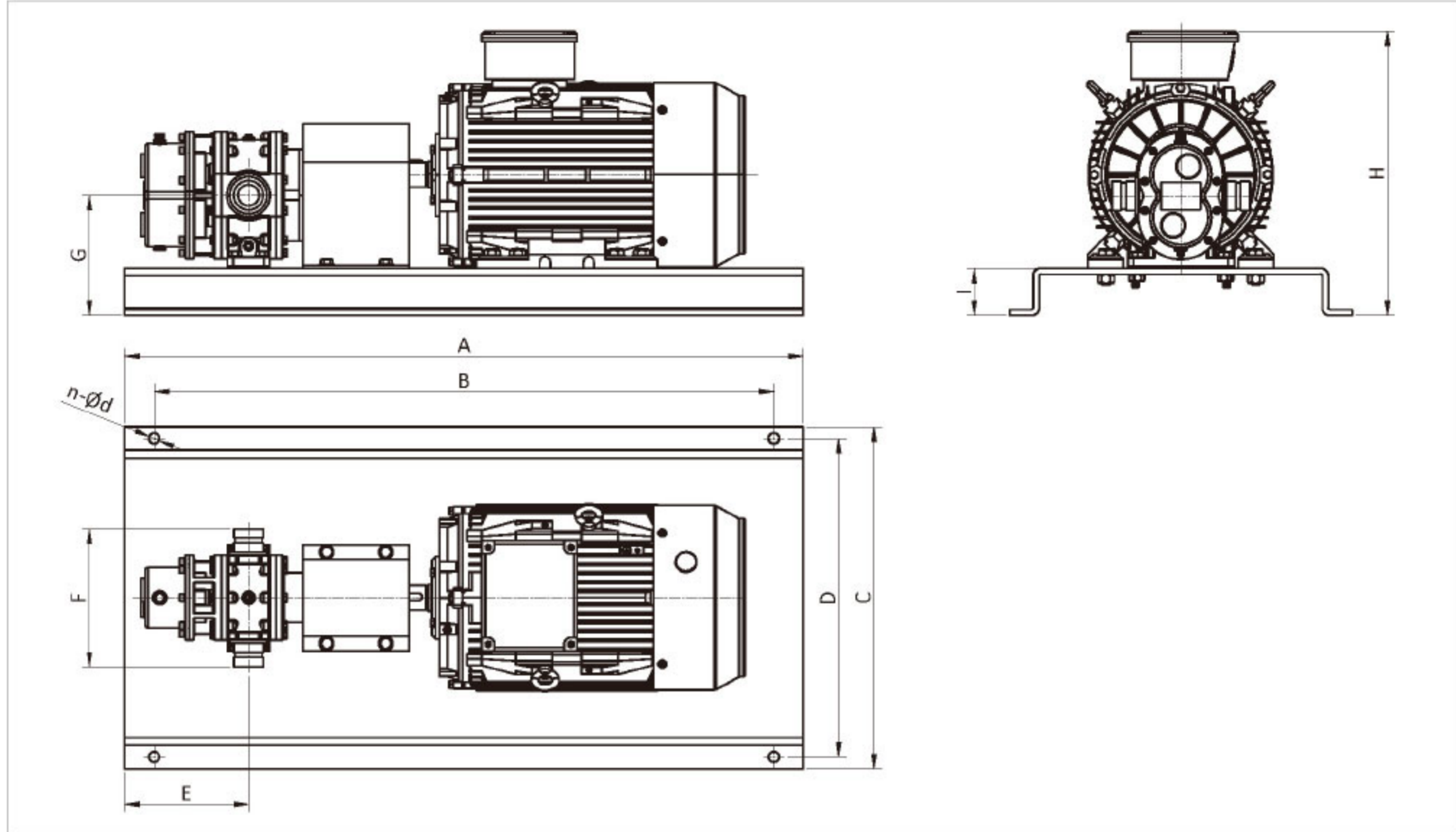

Model	Power	A	B	C	D	E	F	G	H	I	n	d
G6	Kw	mm	mm	mm	mm	mm	mm	mm	mm	mm	-	mm
	5.5	1110	910	500	460	210	234	200	436	80	4	18
	7.5	1110	910	500	460	210	234	200	436	80	4	18
	11.0	1150	1050	580	540	210	234	204	483	80	4	18
	15.0	1150	1050	580	540	210	234	204	483	80	4	18