

## Model G7T-127 Rotary Gear Pump

Surex rotary gear pumps designed for foam extinguishing system. They are Self-Priming and can pump Multiple Viscosities of Foam or Water. This versatile design is suitable for Electric, PTO, Diesel/Gasoline Engine, Water Driven or Hydraulic drive motors.

### Design Features:

- Timing Gears Synchronize the Two Pumping Rotors.
- Timing Gears Allow for DRY Running Without Damage.
- No Rotor Contact Allows for Pumping Foam or Water.
- Water Can Be Used for: Calibration, Testing and Training.

### Technical Data:

Max Pressure: 2.0MPa | 20bar  
 Max Speed: 1800RPM  
 Viscosity : 9500cp max.[1]  
 Connection Diameter: DN80(88.9 O.D.)、3"  
 Connection Type: Groove、Thread、Flange  
 Approvals: FM  
 [1]Brookfield viscometer, spindle #4, speed 30rpm.

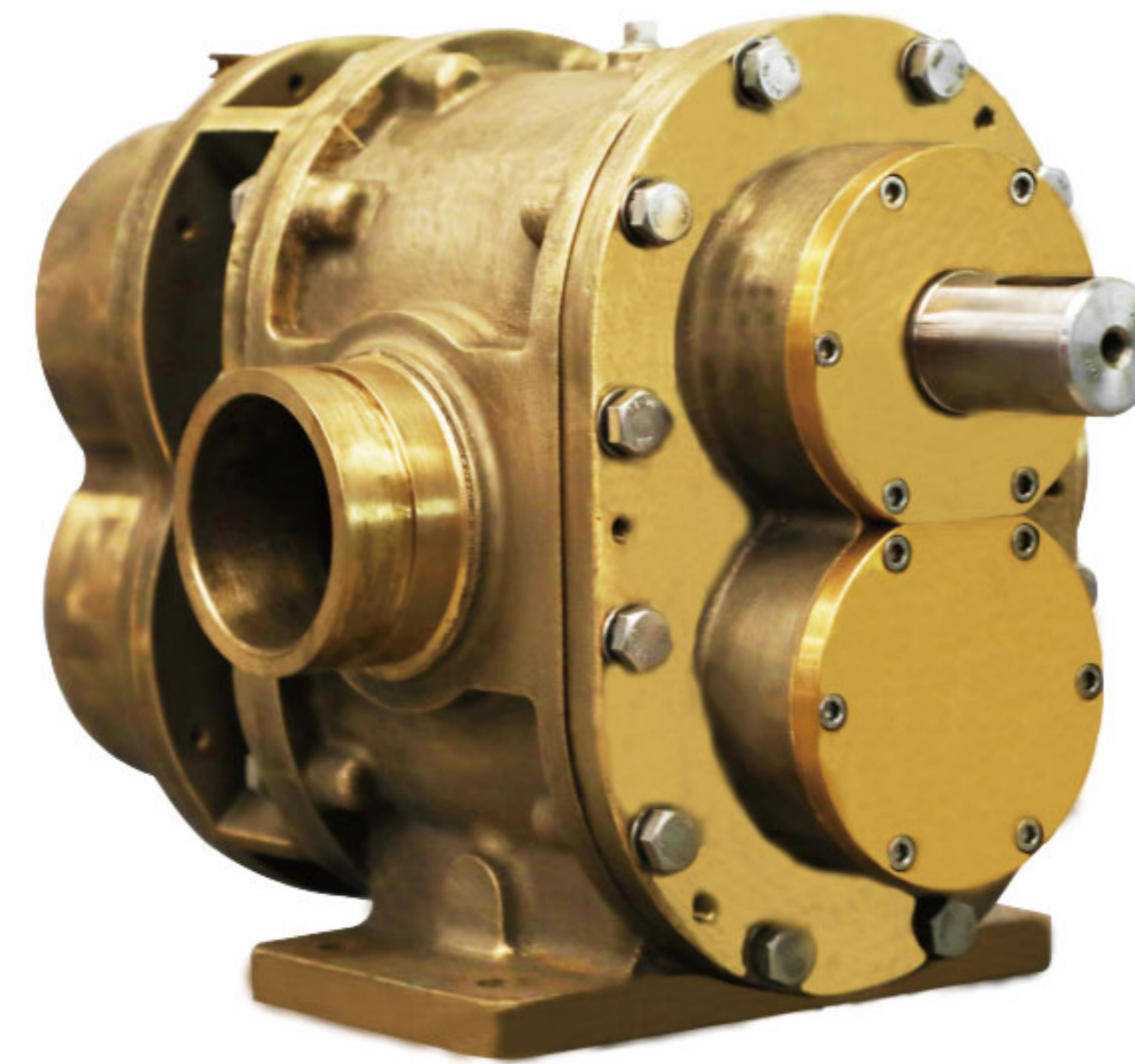

### Materials :

Pump body: Red Brass, ASTM B584 C83600  
 Rotor: Stainless Steel 17-4PH  
 Red Brass, ASTM B584 C83600  
 Liners: Red Brass, ASTM B584 C83600  
 Front Cover: Red Brass, ASTM B584 C83600  
 Back Cover: Red Brass ASTM B584 C83600  
 Timing Gear: Alloy Steel 20CrMnTi (ASTM A29M)  
 Lip Seal : FPM

### Performance -Water

Foam Pump	1000rpm			1200rpm			1500rpm			1800rpm			
	Pressure	Flow	Power	Torque	Flow	Power	Torque	Flow	Power	Torque	Flow	Power	Torque
	bar	L/min	kw	N.m	L/min	kw	N.m	L/min	kw	N.m	L/min	kw	N.m
	5.0	474	8	72	589	10	76	753	13	82	930	17	90
	6.9	458	9	89	573	12	93	742	16	100	913	20	109
	10.3	436	13	120	551	16	125	725	21	133	889	27	141
	13.8	421	16	151	535	20	157	712	26	165	872	33	173
	17.2	415	19	184	528	24	190	703	31	198	862	39	205
	20.0	415	22	210	527	27	215	700	35	225	859	44	231

### Dimensions

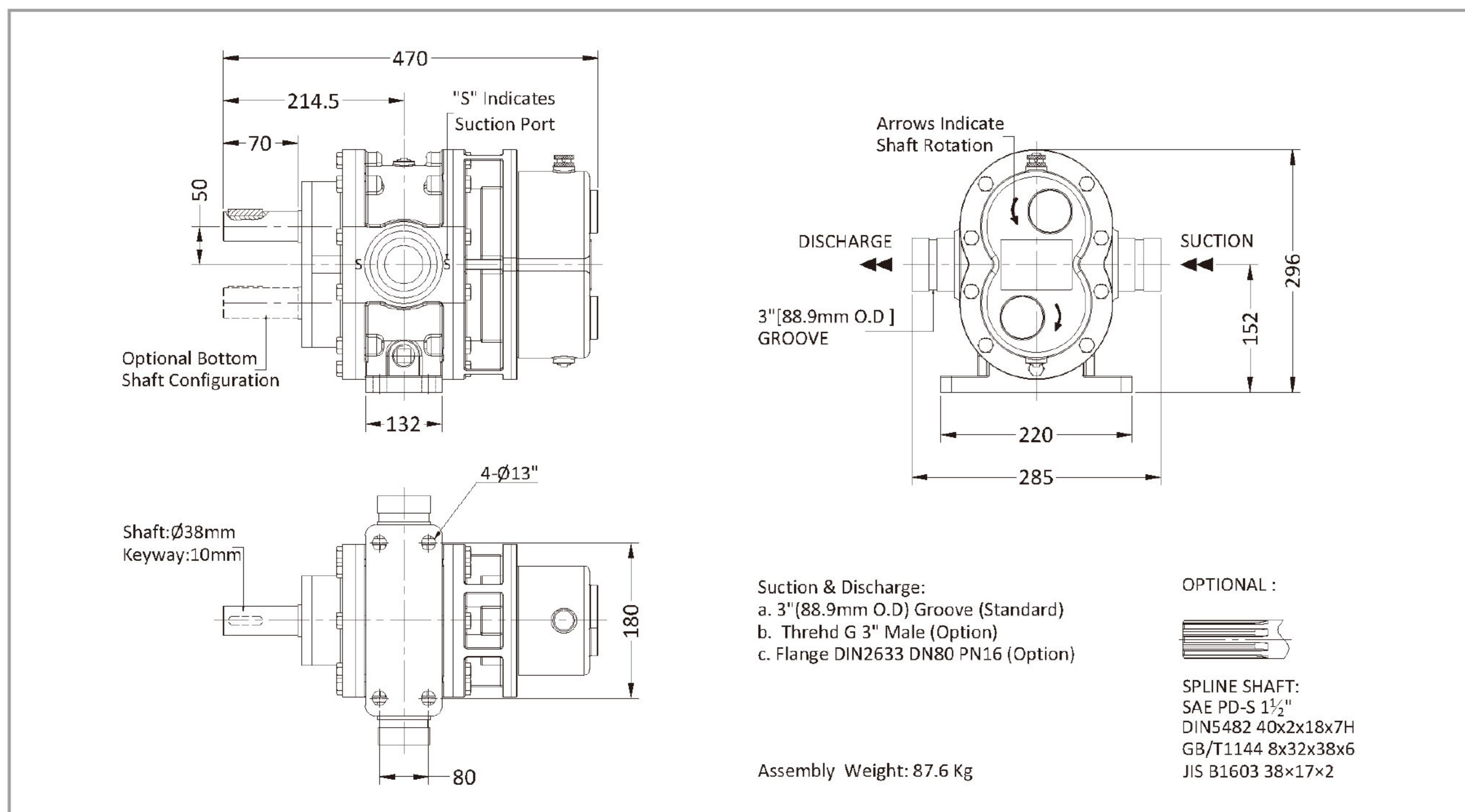

## Model G7T-127 Rotary Gear Pump

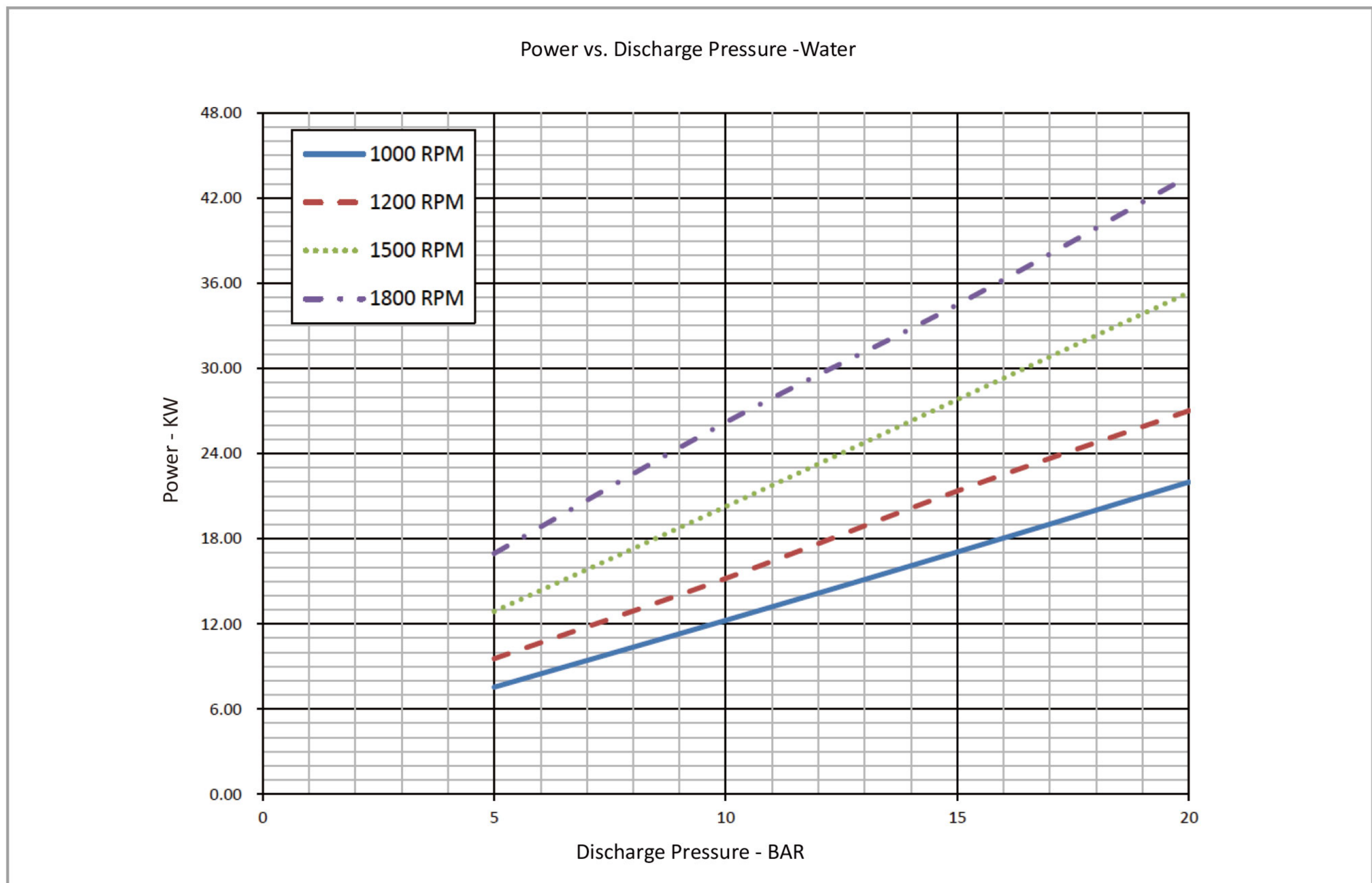
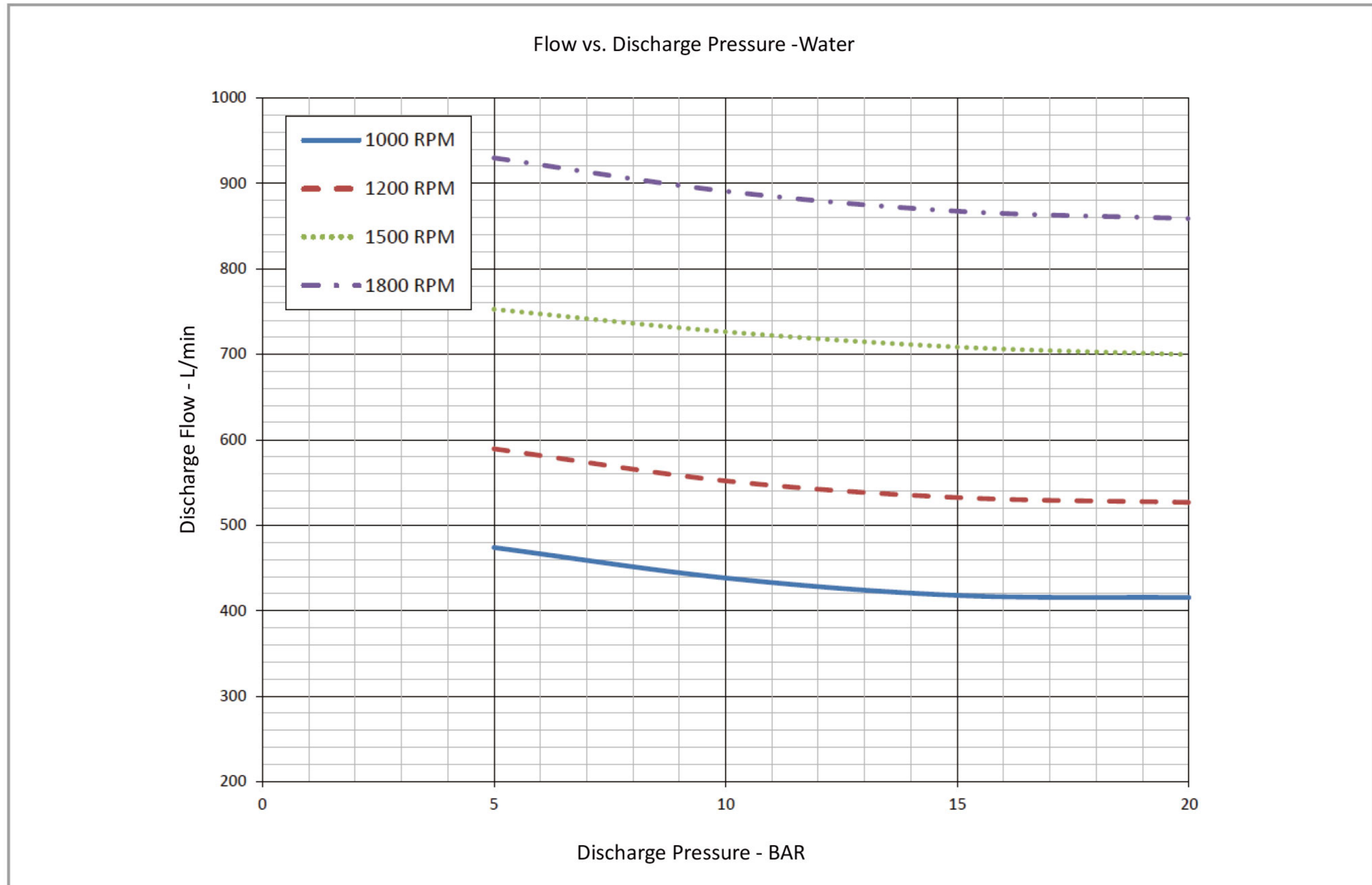

• The pump performance for foam concentrate, please contact Surex, or down load from [www.surexfoam.com](http://www.surexfoam.com).